



Paulmann

### Safety Instructions

1, 2, 3, 4, 5, 6, 10, 11, 13, 14, 19, 22, 23, 24, 25, 26, 33, 34



Info

[www.paulmann.com](http://www.paulmann.com)

Paulmann Licht GmbH  
Quezinger Feld 2  
31832 Springe  
Germany

[www.paulmann.com](http://www.paulmann.com)

Art.-Nr.: 943.94  
943.95  
945.32  
945.79  
945.80



943.94/943.95/945.32/945.79/945.80

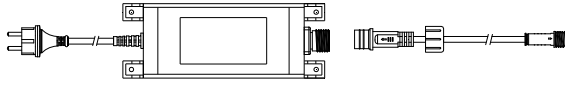

1X

1X

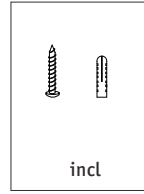

incl

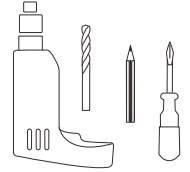

(+MA 326) PXY 05/21



A

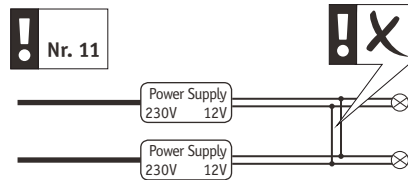
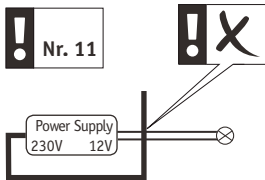
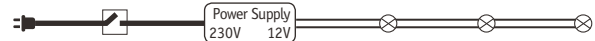
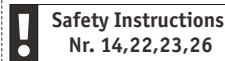
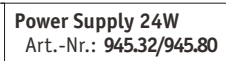
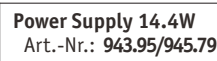
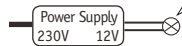
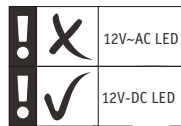
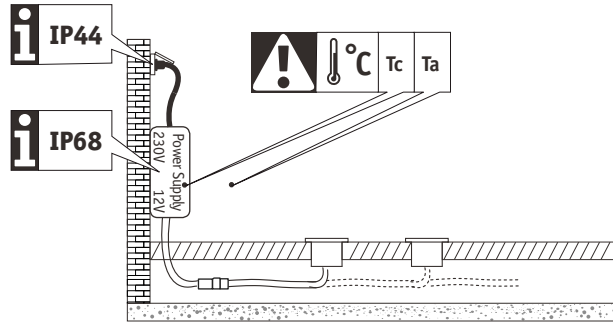

B

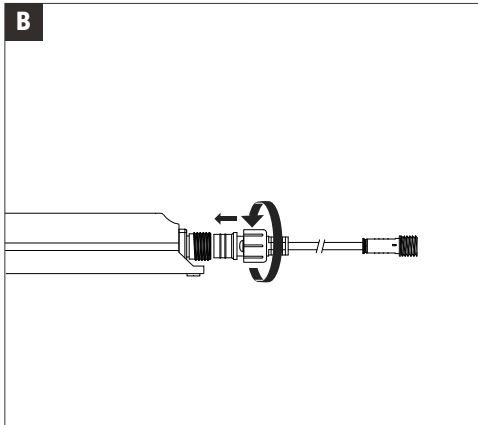

C

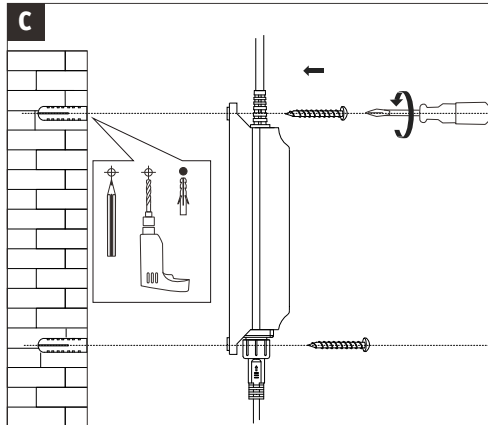

D

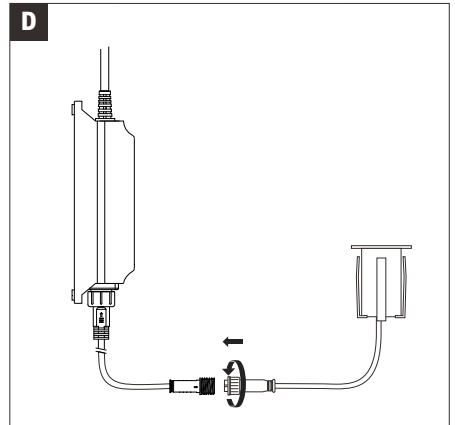

E

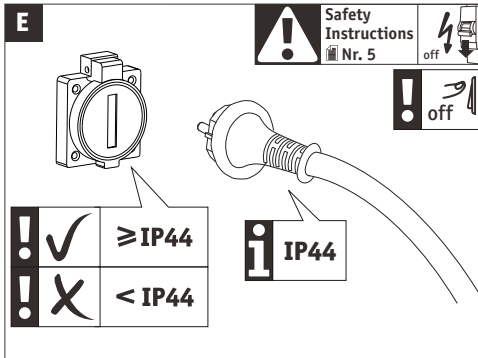

F

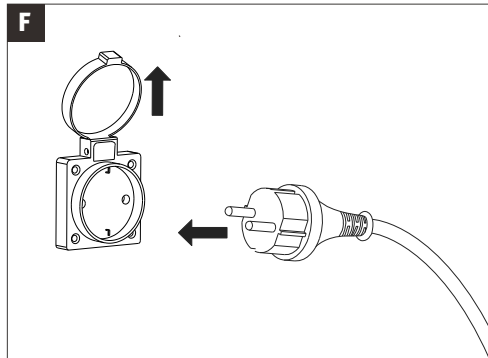

G

