

# PEUGEOT



## EnergySaw-165ASP



132006-MANUAL-B-20180108 MPO

**FR** MANUEL D' UTILISATION (Notice originale):  
**NL** HANDBOEK (Vertaling van het oorspronkelijke):  
**ES** MANUAL (Traducción del original):  
**PT** MANUAL (Tradução do manual original):  
**IT** MANUAL (Traduzione dell'avvertenza originale):  
**EN** USING MANUAL (Original manual translation):

*Scie de table avec aspirateur*  
*Tafelzaag met vacuümtafel*  
*Sierra de mesa con de vacío*  
*Serra da tabela com vácuo*  
*Sega da banco con vuoto*  
*Table saw with vacuum*

[peugeot-1810.com](http://peugeot-1810.com)



FIG. A

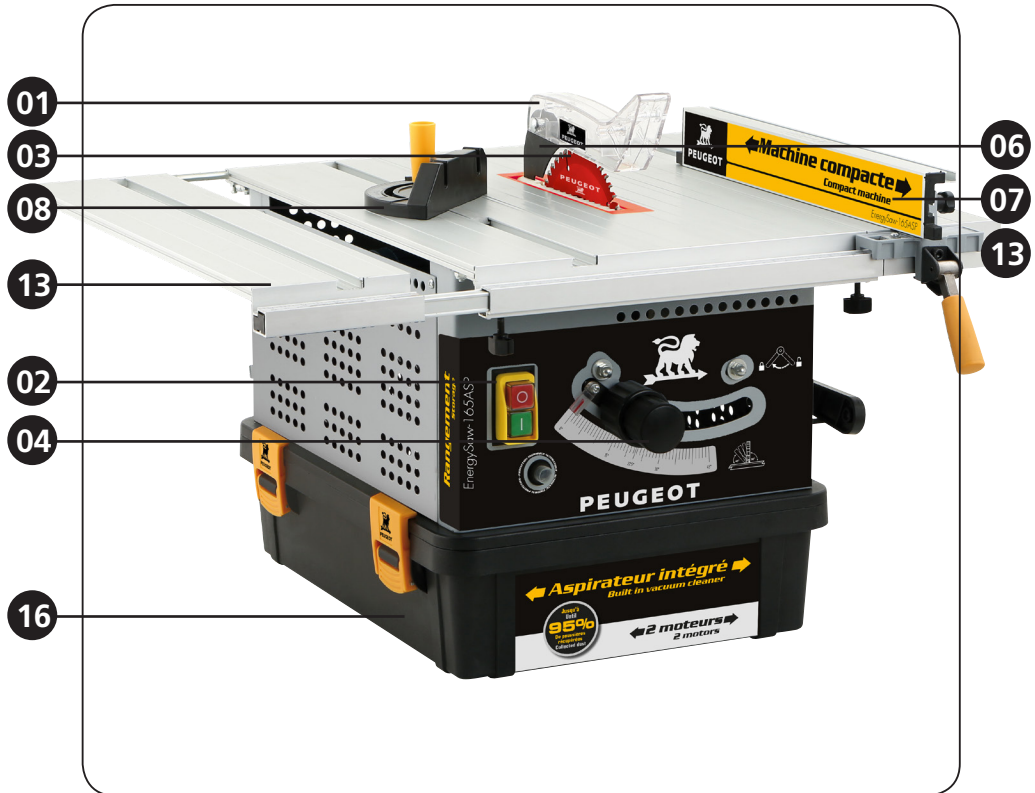

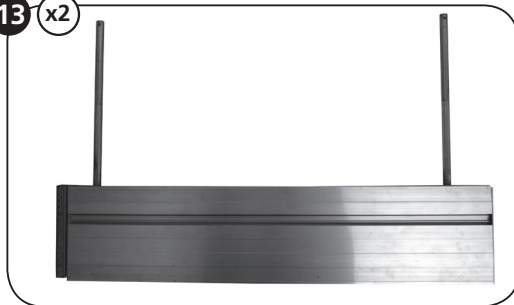

**FIG. B**

Contenu du carton  
Inhoud van de doos  
Conteúdo da caixa  
Contenido de la caja  
Contenuto della confezione  
Contents of the box



**13** x2



**01**

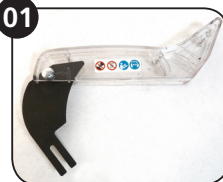

**03**



**17**

x2



**18**

x2



**08**

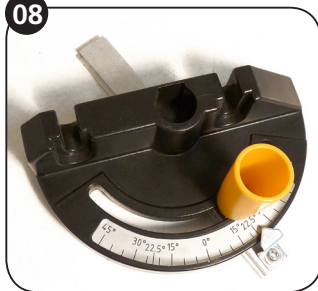

**16**



**19**

x2

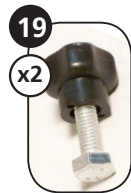

**20**

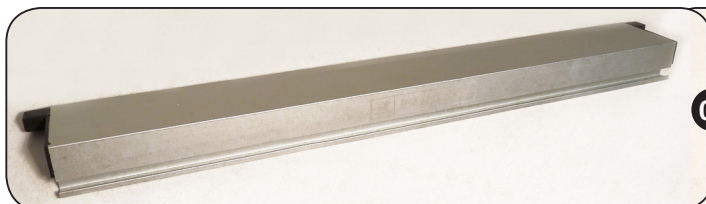

**07**

**15**

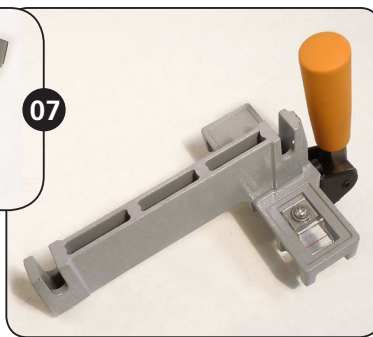
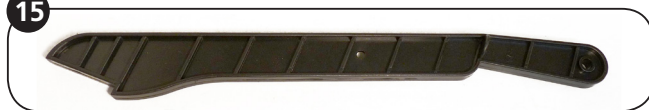
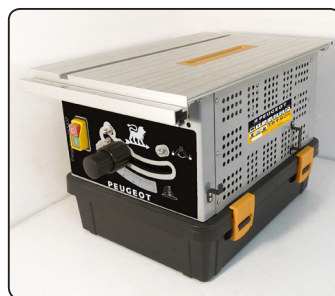
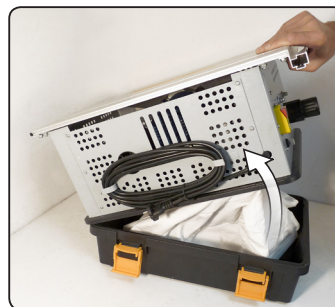
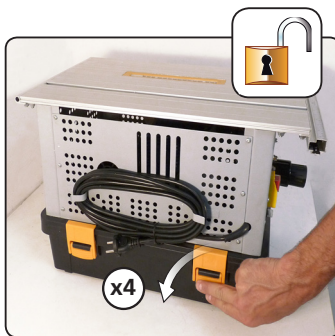



FIG. C

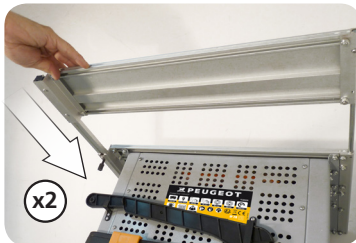



**FIG. D**

**Montage des extensions - Installatie van extensies - Instalación de extensiones -  
Instalação de extensões - Installazione delle estensioni - Installation of extensions**

**03**



**Répéter l'opération pour l'autre côté**  
Herhaal dit voor de andere kant  
Repita para el otro lado  
Repita a operação para o outro lado  
Ripetere l'operazione per l'altro lato  
Repeat operation for the other side

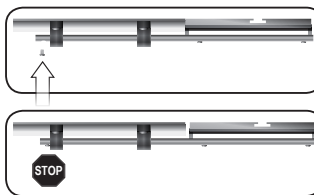
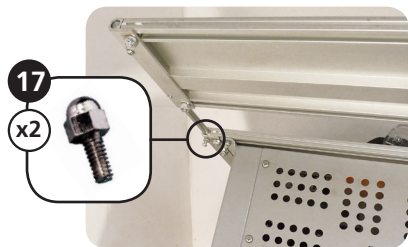

**04**

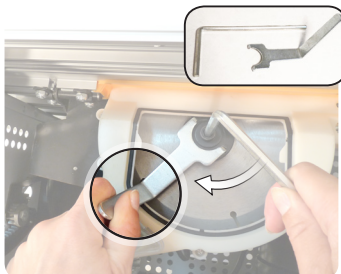
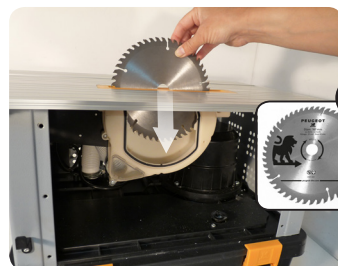
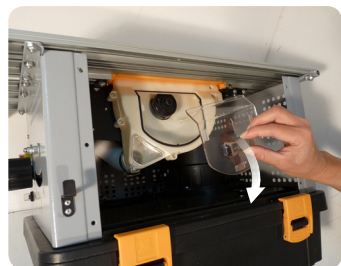
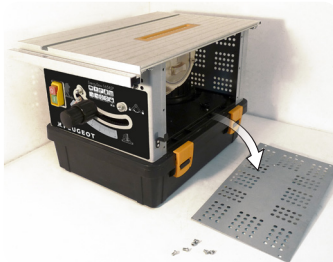



FIG. D

801320

Lame 24 dents pastilles de carbure  
Blade 24 tanden hardmetalen wisselplaten  
Hoja de 24 dientes de carburo de insertos  
Inserre lâmina de 24 dentes de metal duro  
24 T blade  
Lama 24 denti

801321

Lame 50 dents pastilles de carbure  
Blade 50 tanden hardmetalen wisselplaten  
Hoja de 50 dientes de carburo de insertos  
Inserre lâmina de 50 dentes de metal duro  
50 T blade  
Lama 50 denti



OPTION

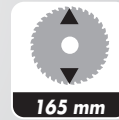

165 mm

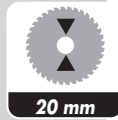

20 mm

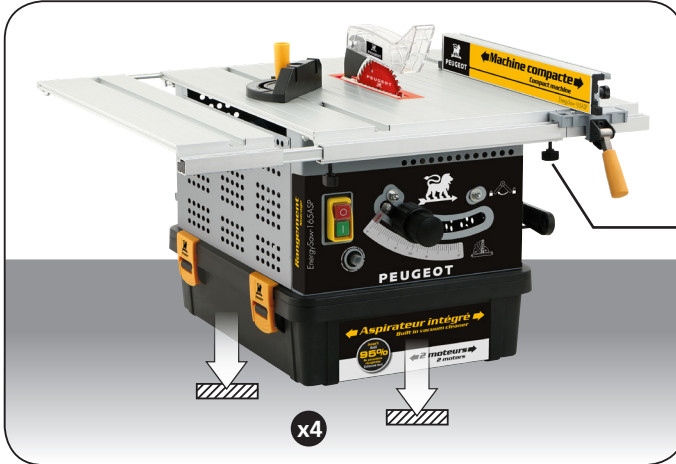

Fixation de l'ensemble  
Vaststelling van de draaibank  
Fijación del torno  
Fixação do Torno  
Fissaggio del tornio  
Fixing the lathe

18

x2

x4



100517

100518

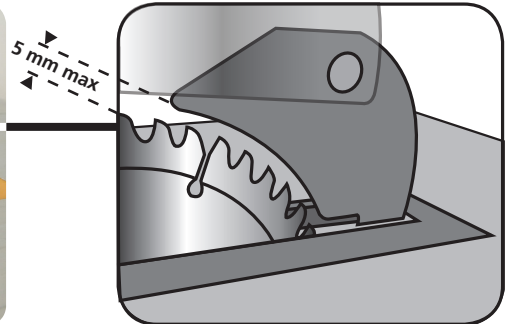
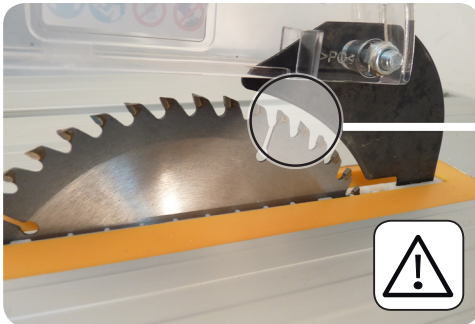
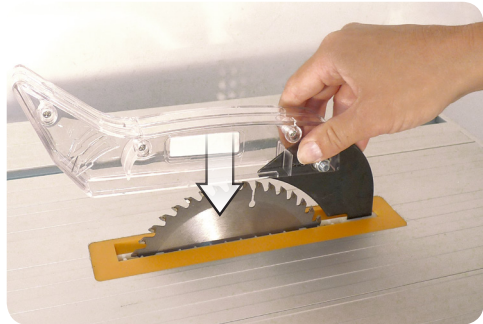
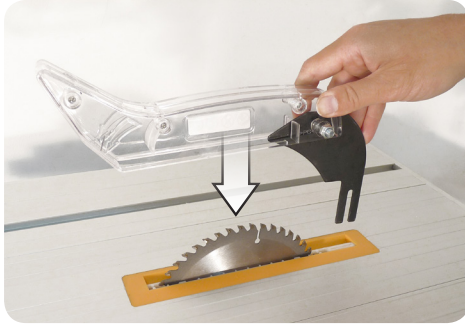



FIG. D

05

01



20



01



02



**Protection thermique** - Thermische beveiliging - La protección térmica - A proteção térmica - Protezione termica - Thermal protection

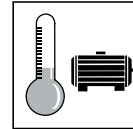
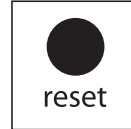
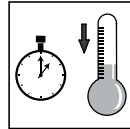
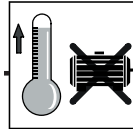

Cette machine est équipée d'une protection thermique. En cas de surchauffe du moteur celui-ci s'arrête automatiquement. Pour le redémarrer, il faut attendre qu'il refroidisse, enclencher le bouton de réarmement et rallumer le moteur.

Deze machine is uitgerust met een thermische beveiliging. In geval van oververhitting van de motor stopt automatisch. Opnieuw starten, te wachten tot het afkoelen, schakelen de reset-knop en opnieuw starten van de motor.

Esta máquina está equipada con una protección térmica. En caso de sobrecalentamiento del motor se detiene automáticamente. Reiniciar, esperar que se enfríe, cambiar el botón de reset y reiniciar el motor.

Esta máquina está equipada com uma proteção térmica. Em caso de sobreaquecimento do motor para automaticamente. Reiniciá-lo, para esperar que arrefeça, interruptor de botão de reset e reiniciar o motor.

Questa macchina è dotata di una protezione termica. In caso di surriscaldamento del motore si arresta automaticamente. Riavviare il sistema, attendere che si raffreddi, portare l'interruttore di reset e riavviare il motore.

This machine is equipped with a thermal protection. In case of overheating of the engine stops automatically. Restart it, to wait for it to cool down, switch the reset button and restart the engine.

## ATTENTION ! / WARNING !

04

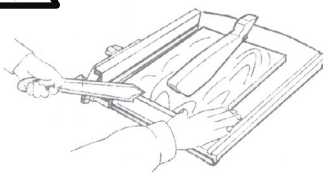
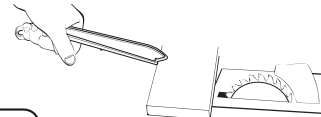

15

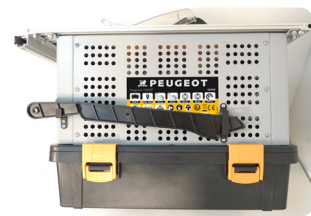





**FIG. E**

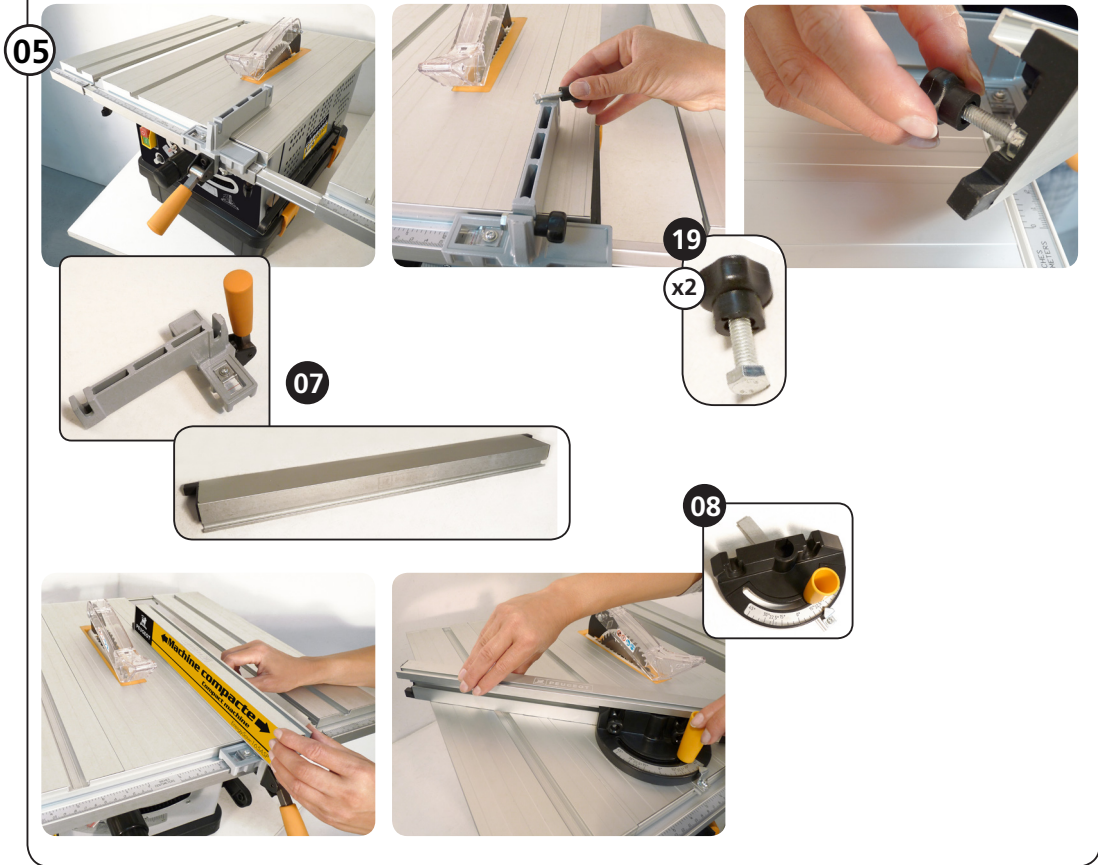



**FIG. E**

**06**

**Transport de la machine**

Vervoeren Machine  
Transporte de la máquina  
Transporte da máquina  
Il trasporto della macchina  
Transportation of the Machine

**Rangement extensions**

Opslag extensies  
Extensiones de almacenamiento  
Extensões de armazenamento  
Estensioni di archiviazione  
Storage extensions



**FIG. F**

**01**

**03**

**90°**



**04**

**45°**

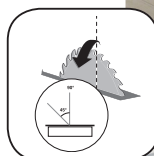
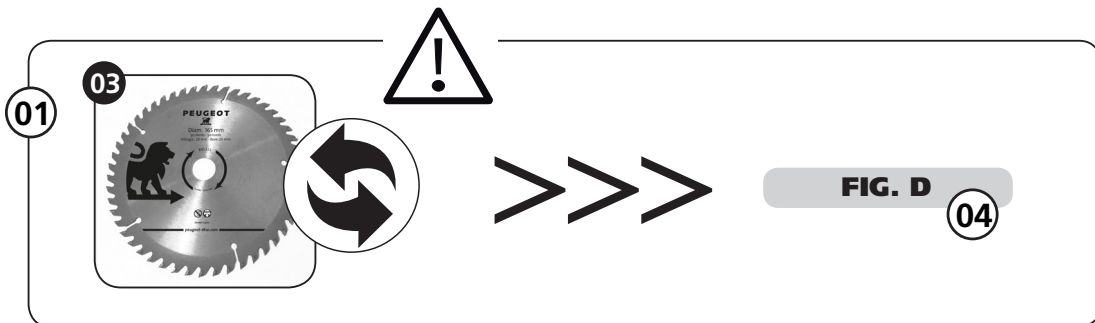



FIG. G





- Cet appareil n'est pas prévu pour être utilisé par des personnes (y compris les enfants) dont les capacités physiques, sensorielles ou mentales sont réduites, ou des personnes dénuées d'expérience ou de connaissance, sauf si elles ont pu bénéficier, par l'intermédiaire d'une personne responsable de leur sécurité, d'une surveillance ou d'instructions préalables concernant l'utilisation de l'appareil.  
- Il convient de surveiller les enfants pour s'assurer qu'ils ne jouent pas avec l'appareil.

- Dit product is niet bedoeld voor gebruik door personen (inclusief kinderen) met een lichamelijke, zintuiglijke of geestelijke vermogens, of gebrek aan ervaring of kennis, tenzij ze zijn gegeven door door een persoon die verantwoordelijk is voor hun veiligheid, toezicht of instructies over het gebruik van het apparaat.  
- Het moet toezicht houden op kinderen om ervoor te zorgen dat zij niet met het apparaat spelen.

- This product is not intended for use by persons (including children) with physical, sensory or mental capabilities, or lack of experience or knowledge, unless they have been given by through a person responsible for their safety, supervision or instruction concerning use of the device.  
- It should supervise children to ensure they do not play with the device.

- Este producto no está diseñado para ser utilizado por personas (incluidos niños) con capacidades físicas, sensoriales o mentales, o la falta de experiencia o conocimiento, a menos que hayan sido dadas por través de una persona responsable de su seguridad, supervisión o instrucciones relativas al uso del dispositivo.  
- Se debe supervisar a los niños para asegurarse de que no jueguen con el dispositivo.

- Este produto não é destinado ao uso por pessoas (incluindo crianças) com capacidades físicas, sensoriais ou mentais, ou falta de experiência ou conhecimento, a menos que tenham sido dadas por através de uma pessoa responsável pela sua segurança, supervisão ou instruções relativas à utilização do dispositivo.  
- Deve vigiar as crianças para garantir que eles não brincam com o dispositivo.



**Description et repérage des organes de la machine****FIG. A**

- 01 Carter de protection
- 02 Interrupteur
- 03 Lame
- 04 Inclinaison de lame
- 05 -
- 06 Couteau diviseur
- 07 Guide parallèle
- 08 Guide d'angle
- 09 -
- 10 -
- 11 -
- 12 -
- 13 Extensions de table
- 14 -
- 15 Poussoir
- 16 Aspirateur

**Contenu du carton****FIG. B****Assemblage de la machine****FIG. C**

- 01 -
- 02 -
- 03 Montage des extensions
- 04 Montage de la lame
- 05 Montage du carter
- 06 -

**Fonctionnalité de la machine****FIG. D**

- 01 Mise en marche et arrêt
- 02 -
- 03 -
- 04 Utilisation du poussoir
- 05 Utilisation des guides
- 06 Transport & rangement des extensions
- 07 -
- 08 -
- 09 -
- 10 -

**Réglages de la machine****FIG. E**

- 01 Réglage de la coupe à 90°
- 02 -
- 03 Réglage de la coupe à 45°
- 04 -

**Remplacement des consommables****FIG. F**

- 01 Changement de la lame
- 02 -
- 03 -

**Entretien, recommandations et conseils**

- 01 Ne pas utiliser pour la coupe de bois de chauffage
- 02 Le choix de la lame est important. Adapter la denture au matériau à couper.

- < 36 dents = Coupe rapide, délignage, sur bois tendre.

- 36 à 60 dents = Coupe de dérivé du bois (aggloméré, stratifié...). Coupe de bois dur.

- > 60 dents = Coupe précise. Coupe de matière plastique. Coupe de petite section.

- 03 -
- 04 -
- 05 -
- 06 -

## Beschrijving en plaatsbepaling van de onderdelen van de machine

## FIG. A

- 01 Beschermmantel
- 02 Schakelaar
- 03 Zaagblad
- 04 Kantelhoek van het zaagblad
- 05 -
- 06 Verdeelmes
- 07 Parallele geleider
- 08 Profielgeleider
- 09 -
- 10 -
- 11 -
- 12 -
- 13 Tafelverlengingen
- 14 -
- 15 Drukknop
- 16 Stofzuiger

## Inhoud van het karton

## FIG. B

## Assemblage van de machine

## FIG. C

- 01 -
- 02 -
- 03 Montage van de verlengingen
- 04 Montage van het zaagblad
- 05 Montage van het carter
- 06 -

## Functionaliteit van de machine

## FIG. D

- 01 Aanzetten en stoppen
- 02 -
- 03 -
- 04 Gebruik van de drukknoop
- 05 Gebruik van de geleiders
- 06 Transport & opslag van uitbreidingen
- 07 -
- 08 -
- 09 -
- 10 -

## afstellingen van de machine

## FIG. E

- 01 Afstelling van het versnijden op 90°
- 02 Afstelling van de Laser
- 03 Afstelling van het versnijden op 45°
- 04 -

## Vervanging van de accessoires

## FIG. F

- 01 Verandering van de lamel
- 02 -
- 03 -

## Reiniging en onderhoud

- 01 Niet gebruiken om brandhout te zagen
- 02 De keuze van het zaagblad is belangrijk. De tanden moeten aangepast zijn aan het te zagen materiaal.

- < 36 tanden = snel zagen, markeren op zacht hout.  
 - 36 à 60 tanden = zagen van houtderivaten (spaanderplaat, gelaagd hout...). Zagen van hard hout.  
 - > 60 tanden = nauwkeurig zagen. Zagen van plastics.

Zagen van dunne stukken.

- 03 -
- 04 -
- 05 -
- 06 -

## Description and location of machine parts

## FIG. A

- 01 Protection guard
- 02 Switch
- 03 Slade
- 04 Blade inclination
- 05 -
- 06 Board splitter
- 07 Parallel guide
- 08 Angle guide
- 09 -
- 10 -
- 11 -
- 12 -
- 13 Table extensions
- 14 -
- 15 Pushbutton
- 16 Vacuum cleaner

## Contents of box

## FIG. B

## Assembling the machine

## FIG. C

- 01 -
- 02 -
- 03 Mounting of extensions
- 04 Blade assembly
- 05 Mounting of guard
- 06 -

## Functions of the machine

## FIG. D

- 01 Switch on/off
- 02 -
- 03 -
- 04 Use of the pushbutton
- 05 Use of the guides
- 06 Transport & Storage of extensions
- 07 -
- 08 -
- 09 -
- 10 -

## Settings of the machine

## FIG. E

- 01 Adjusting a cut to 90°
- 02 -
- 03 Adjusting a cut to 45°
- 04 -

## Replacing consumables

## FIG. F

- 01 Changing the blade
- 02 -
- 03 -

## Cleaning and maintenance

- 01 Do not use for cutting logs
- 02 The choice of blade is important. Adapt the saw teeth to the material to be cut.

- < 36 teeth = Rapid cut, edging, on soft wood.  
 - 36 to 60 teeth = Cutting wood products (chipboard, laminates etc.). Cutting hard wood.  
 - > 60 teeth = Precise cutting. Cutting plastic.

Cutting small sections.

- 03 -
- 04 -
- 05 -
- 06 -

## Descripción y localización de los elementos de la máquina

## FIG. A

- 01 Cárter de protección
- 02 Interruptor
- 03 Hoja
- 04 Inclinación de la hoja
- 05 -
- 06 Cuchillo divisor
- 07 Guía paralela
- 08 Guía angular
- 09 -
- 10 -
- 11 -
- 12 -
- 13 Extensiones de la mesa
- 14 -
- 15 Empujador
- 16 Aspiradora

## Contenido del cartón

## FIG. B

## Ensamblaje de la máquina

## FIG. C

- 01 -
- 02 -
- 03 Montaje de las extensiones
- 04 Montaje de la hoja
- 05 Montaje del cárter
- 06 -

## Funcionalidad de la máquina

## FIG. D

- 01 Puesta en marcha y parada
- 02 -
- 03 -
- 04 Utilización del empujador
- 05 Utilización de las guías
- 06 Transporte y almacenamiento de extensiones
- 07 -
- 08 -
- 09 -
- 10 -

## Ajustes de la máquina

## FIG. E

- 01 Ajuste del corte a 90°
- 02 -
- 03 Ajuste del corte a 45°
- 04 -

## Cambio de los consumibles

## FIG. F

- 01 Cambio de hoja
- 02 -
- 03 -

## Limpieza y mantenimiento

- 01 No utilizar para cortar leña de calefacción
- 02 La elección de la hoja es importante. Adaptar los dientes al material que se tiene que cortar.

- < 36 dientes = Corte rápido, canteado, en madera blanda.  
 - 36 a 60 dientes = Corte de derivados de madera (conglomerado, estratificado...). Corte de madera dura.  
 - > 60 dientes = Corte preciso. Corte de materias plásticas.

Corte de pequeñas secciones.

- 03 -
- 04 -
- 05 -
- 06 -



## Descrição e identificação dos órgãos

## FIG. A

- 01 Cárter de proteção
- 02 Interruptor
- 03 Lâmina
- 04 Inclinação da lâmina
- 05 -
- 06 Lâmina separadora
- 07 Guia paralela
- 08 Guia angular
- 09 -
- 10 -
- 11 -
- 12 -
- 13 Extensões de mesa
- 14 -
- 15 Empurrador
- 16 Aspirador de pó

## Conteúdo da caixa

## FIG. B

## Montagem da máquina

## FIG. C

- 01 -
- 02 -
- 03 Montagem das extensões
- 04 Montagem da lâmina
- 05 Montagem do cárter
- 06 -

## Funcionalidade da máquina

## FIG. D

- 01 Accionamento e paragem
- 02 -
- 03 -
- 04 Utilização do empurrador
- 05 Utilização das guias
- 06 Transporte e armazenamento de extensões
- 07 -
- 08 -
- 09 -
- 10 -

## Ajustes da máquina

## FIG. E

- 01 Ajuste do corte a 90°
- 02 -
- 03 Ajuste do corte a 45°
- 04 -

## Substituição de consumíveis

## FIG. F

- 01 Substituição da lâmina
- 02 -
- 03 -

## Limpeza e manutenção preventiva

- 01 Não utilizar para o corte de madeira de lenha
- 02 A escolha da lâmina é importante. Adaptar os dentes ao material a cortar.

- < 36 dentes = Corte rápido, corte longitudinal, em madeira macia.

- 36 a 60 dentes = Corte de derivados de madeira (aglomerados, estratificados, etc.). Corte de madeira dura.

- > 60 dentes = Corte preciso. Corte de matérias plásticas.

Corte de pequena secção.

- 03 -
- 04 -
- 05 -
- 06 -

## Descrizione e localizzazione degli organi della macchina

## FIG. A

- 01 Carter di protezione
- 02 Interruttore
- 03 Lama
- 04 Inclinazione della lama
- 05 -
- 06 Coltello divisore
- 07 Guida parallela
- 08 Guida ad angolo
- 09 -
- 10 -
- 11 -
- 12 -
- 13 Estensioni del tavolo
- 14 -
- 15 Punteria
- 16 Aspirapolvere

## Contenuto della scatola

## FIG. B

## Assemblaggio della macchina

## FIG. C

- 01 -
- 02 -
- 03 Montaggio delle estensioni
- 04 Montaggio della lama
- 05 Montaggio del carter
- 06 -

## Funzionalità della macchina

## FIG. D

- 01 Avvio e arresto
- 02 -
- 03 -
- 04 Utilizzazione della punteria
- 05 Utilizzazione delle guide
- 06 Trasporto e stoccaggio di prolunghe
- 07 -
- 08 -
- 09 -
- 10 -

## regolazioni della macchina

## FIG. E

- 01 Regolazione del taglio a 90°
- 02 -
- 03 Regolazione del taglio a 45°
- 04 -

## Sostituzione dei pezzi di ricambio

## FIG. F

- 01 Cambiare la lama
- 02 -
- 03 -

## Pulizia e manutenzione



- 01 Non usare per tagliare la legna
- 02 La scelta della lama è importante. Adattare la dentatura al materiale da tagliare.



- < 36 denti = Taglio rapido, rifilatura, su legno dolce.  
 - da 36 a 60 denti = Taglio del derivato del legno (conglomerato, stratificato...). Taglio del legno duro.  
 - > 60 denti = Taglio preciso. Taglio di materie plastiche.

Taglio di piccole sezioni.



- 03 -
- 04 -
- 05 -
- 06 -

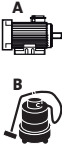

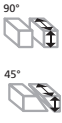

|   |                                    |                      |   |                  |                |
|---|------------------------------------|----------------------|---|------------------|----------------|
|  | TENSION ET FRÉQUENCE ASSIGNÉE:     | <b>230 V ~ 50 Hz</b> |  | LAME INCLINABLE: | <b>0 - 45°</b> |
|   | AANGEWEZEN SPANNING EN FREQUENTIE: |                      |   | TILTING BLADE:   |                |
|   | TENSIÓN Y FRECUENCIA FIJADA:       |                      |   | TILT BLADE:      |                |
|   | TENSÃO E FREQUÊNCIA FIXA:          |                      |   | INCLINE LA HOJA: |                |
|   | TENSIONE E FREQUENZA ASSEGNATA:    |                      |   | INCLINE BLADE:   |                |
| NOMINAL FREQUENCY AND POWER:  | INCLINARE LAMA:                    |                      |   |                  |                |



|   |                     |  |   |                     |                     |
|---|---------------------|--|---|---------------------|---------------------|
|  | PUISSANCE ASSIGNÉE: | <b>A : 1200 W 51<br/>B : 1000 W 51</b> |  | DIMENSIONS TABLE:   | <b>515 x 340 mm</b> |
|   | NOMINAL POWER:      |  |   | TABLE SIZES:        |                     |
|   | LEERLAUFDREHZAHL:   |  |   | LIJSTGROOTTE:       |                     |
|   | POTENCIA FIJADA:    |  |   | TAMAÑO DE LA TABLA: |                     |
|   | POTENZA ASSEGNATA:  |  |   | TAMANHO DA TABELA:  |                     |
|   | POTÊNCIA ASSINADA:  |  |   | DIMENSIONI TAVOLO:  |                     |

|   |                        |          |   |                       |                                    |
|---|------------------------|----------|---|-----------------------|------------------------------------|
|  | CLASSE D'ISOLEMENT : 2 | <b>X</b> |  | CAPACITÉS DE COUPE:   | <b>45° = 24 mm<br/>90° = 40 mm</b> |
|   | ISOLATIE KLASSE: 2     |          |   | CUTTING CAPACITIES:   |                                    |
|   | AISLAMIENTO CLASE: 2   |          |   | SNIJDEN CAPACITEITEN: |                                    |
|   | ISOLAMENTO CLASSE: 2   |          |   | CAPACIDADES DE CORTE: |                                    |
|   | ISOLAMENTO CLASSE: 2   |          |   | CORTAR CAPACIDADES:   |                                    |
| INSULATION CLASS: 2   | DI TAGLIO:             |          |   |                       |                                    |

|   |                      |                              |   |   |          |
|---|----------------------|------------------------------|---|---|----------|
|  | VITESSE À VIDE:      | <b>5300 min<sup>-1</sup></b> |  | LIRE LES INSTRUCTIONS AVANT USAGE :     | <b>X</b> |
|   | LEERLAUFDREHZAHL:    |                              |   | LEES VOOR HET GEBRUIK DE INSTRUCTIES :  |          |
|   | VELOCIDAD VACÍA:     |                              |   | LÉASE LAS INSTRUCCIONES ANTES DE USAR : |          |
|   | VELOCITÀ A VUOTO:    |                              |   | LER AS INSTRUÇÕES ANTES DA UTILIZAÇÃO : |          |
|   | VELOCIDADE NO VÁCUO: |                              |   | LEGGERE LE ISTRUZIONI PRIMA DELL'USO :  |          |
|   | NO-LOAD SPEED:       |                              |   | READ THE INSTRUCTIONS BEFORE USE :      |          |



|   |           |              |   |                                |          |
|---|-----------|--------------|---|--------------------------------|----------|
|  | POIDS :   | <b>16 kg</b> |  | CONFORMITÉ EUROPÉENNE :        | <b>X</b> |
|   | GEWICHT : |              |   | VOLDOET AAN DE EG-NORMEN :     |          |
|   | PESO :    |              |   | CUMPLE CON LAS DIRECTIVAS CE : |          |
|   | PESO :    |              |   | CONFORME ÀS NORMAS CE :        |          |
|   | PESO :    |              |   | CONFORME ALLE NORME CE :       |          |
|   | WEIGHT :  |              |   | CONFORMS TO EC STANDARDS :     |          |

|   |                          |                       |   |            |          |
|---|--------------------------|-----------------------|---|------------|----------|
|  | DIMENSIONS LAME:         | <b>∅ 165 mm - 50T</b> |  | DANGER :   | <b>X</b> |
|   | BLADE SIZES:             |                       |   | GEVAAR :   |          |
|   | PANEEL AFMETINGEN:       |                       |   | PELIGRO :  |          |
|   | DIMENSIONES DEL PANEL:   |                       |   | PERIGO :   |          |
|   | DIMENSÕES DO PAINEL:     |                       |   | PERICOLO : |          |
|   | DIMENSIONI DEL PANNELLO: |                       |   | DANGER :   |          |

|   |                           |                |   |                                   |          |
|---|---------------------------|----------------|---|-----------------------------------|----------|
|  | ALÉSAGE LAME:             | <b>∅ 20 mm</b> |  | PORTER DES GANTS :                | <b>X</b> |
|   | BORE:                     |                |   | DRAAG VEILIGHEIDSHANDSCHOENEN:    |          |
|   | BLADE BORING:             |                |   | LLEVAR GUANTES DE PROTECCIÓN:     |          |
|   | PERFORACIÓN DE LA LÁMINA: |                |   | UTILIZAR LUVAS DE PROTECCIÓN:     |          |
|   | FURO LÁMINA:              |                |   | INDOSSARE I GUANTI DI PROTEZIONE: |          |
|   | FORO LAMA:                |                |   | USE RUBBER GLOVES:                |          |





|   |                                  |                     |
|---|----------------------------------|---------------------|
| <b>IP 20</b>  |                                  | <b>X</b>            |
|  | NIVEAU DE PRESSION ACOUSTIQUE :  | <b>89,8 dB (A)</b>  |
|   | NIVEAU AKOESTISCHE DRUK :        |                     |
|   | NIVEL DE PRESIÓN ACÚSTICA :      |                     |
|   | NÍVEL DE PRESSÃO ACÚSTICA :      |                     |
|   | LIVELLO DI PRESSIONE ACUSTICA :  |                     |
| ACOUSTIC PRESSURE LEVEL :   |                                  |                     |
|  | NIVEAU DE PUISSANCE ACOUSTIQUE : | <b>102,8 dB (A)</b> |
|   | NIVEAU AKOESTISCH VERMOGEN :     |                     |
|   | NIVEL DE POTENCIA ACÚSTICA :     |                     |
|   | NÍVEL DE POTÊNCIA ACÚSTICA :     |                     |
|   | LIVELLO DI POTENZA ACUSTICA :    |                     |
| ACOUSTIC POWER LEVEL :  |                                  |                     |

**NIVEAU SONORE D'EMISSION:****A VIDE**

Pression acoustique LpA poste opérateur  
Incertitude

89,8 dB  
3

Puissance acoustique LWA  
Incertitude

102,8 dB  
3

VALEURS DÉTERMINÉES SUIVANT LE CODE D'ESSAI DE L'ANNEXE B DE LA NORME EN 61029-1 AVEC EMPLOI DES NORMES DE BASE ISO 11201 ET ISO 3744.

LES NIVEAUX DE PRESSION ACOUSTIQUE OBTENUS IN SITU DÉPENDENT:

- DES NIVEAUX RÉELS DE LA MACHINE CONSIDÉRÉES, EN PRENANT EN COMPTE LES INCERTITUDES DÉCLARÉES.
- DU LOCAL ET DE L'INSTALLATION DE LA MACHINE. PRÉFÉREZ UNE PIÈCE DONT L'ACOUSTIQUE EST PLUS FEUTRÉE. ÉVITEZ LES PIÈCES VIDE À GRANDE RÉSONNANCE. PLACEZ VOUS AUPRÈS D'UNE FENÊTRE LE CAS ÉCHÉANT.
- DES OUTILS MONTÉS, DES PIÈCES TRAVAILLÉES, DES RÉGLAGES CHOISIS,...

|   |  |          |
|---|--|----------|
|  | PORTER DES LUNETTES DE SÉCURITÉ :      | <b>X</b> |
|   | DRAAG EEN VEILIGHEIDSBRIL :            |          |
|   | LLEVAR PUESTAS GAFAS PROTECTORAS :     |          |
|   | UTILIZAR ÓCULOS DE SEGURANÇA :         |          |
|   | PORTARE DE GLI OCCHIALI DI SICUREZZA : |          |
| WEAR PROTECTIVE EYEWEAR :   |  |          |

|   |                                   |          |
|---|-----------------------------------|----------|
|  | PORTER UNE PROTECTION AUDITIVE :  | <b>X</b> |
|   | DRAAG GEHOORBESCHERMERS :         |          |
|   | UTILIZAR UMA PROTECÇÃO AUDITIVA : |          |
|   | UTILIZAR UMA PROTECÇÃO AUDITIVA : |          |
|   | PORTARE UNA PROTEZIONE UDDITIVA : |          |
| WEAR HEARING PROTECTIVE EQUIPMENT :   |                                   |          |

|   |  |          |
|---|--|----------|
|  | PORTER UN MASQUE ANTI-POUSSIÈRE :                        | <b>X</b> |
|   | DRAAG EEN STOFMASKER :                                   |          |
|   | LLEVAR PUESTA UNA CARETA DE PROTECCIÓN CONTRA EL POLVO : |          |
|   | UTILIZAR UMA MÁSCARA ANTI-POEIRA :                       |          |
|   | INDOSSARE UNA MASCHERINA ANTI-POLOVERE :                 |          |
| WEAR A DUST MASK :  |  |          |

|   |  |          |
|---|--|----------|
|  | RISQUE DE SECTIONNEMENT DES DOIGTS OU DE LA MAIN : | <b>X</b> |
|   | SNIJDEN RISICO VAN DE VINGER OF HAND :             |          |
|   | RECYCLEBAAR, ONDER VOORBEHOUD VAN HET SORTEREN :   |          |
|   | SECCIONAMIENTO RIESGO DEL DEDO O DE LA MANO :      |          |
|   | RISCO SECCIONAMENTO DO DEDO OU A MÃO :             |          |
| SEZIONAMENTO RISCHIO DEL DITO O DELLA MANO :  |  |          |





|                          |                            |   |
|--------------------------|----------------------------|---|
|                          | SOU MIS À RECYCLAGE :      | X |
|                          | NIET WEGWERPEN :           |   |
|                          | SOTTOPOSTI A RICICLAGGIO : |   |
|                          | SUJEITOS À RECICLAGEM :    |   |
|                          | SOTTOPOSTI A RICICLAGGIO : |   |
| SUBJECTED TO RECYCLING : |                            |   |

**FR-RECYCLAGE DES DÉCHETS:**

LES OUTILS, ACCESSOIRES ET LEUR EMBALLAGES DOIVENT SUIVRE UNE VOIE DE RECYCLAGE ADAPTÉE. CONFORMÉMENT AUX DIRECTIVES EUROPÉENNE 2012/19/UE ET 2006/66/CE, LES COMPOSANTS D'UN PRODUIT DOIVENT ÊTRE SÉPARÉS, COLLECTÉS, RECYCLÉS OU ÉLIMINÉS EN CONFORMITÉ AVEC LES RÉGLEMENTATIONS ENVIRONNEMENTALES EN VIGUEUR. LES APPAREILS, BATTERIES, PILES, HUILES, EMBALLAGES DEVRONT ÊTRE DÉPOSÉS DANS LES SYSTÈMES D'ÉLIMINATION DES DÉCHETS SPÉCIAUX TELS QUE DÉCHETTERIES. RENSEIGNEZ VOUS AUPRÈS DE VOTRE COMMUNE POUR CONNAÎTRE L'ORGANISME LE PLUS PROCHE À MÊME DE RETRAITER OU DE COLLECTER CES DÉCHETS.

**NL-AFVAL RECYCLING:**

GEREEDSCHAP, ACCESSOIRES EN VERPAKKINGEN MOETEN VOLGEN EEN PAD GESCHIKT IS VOOR RECYCLING. VOLGENS DE EUROPESE RICHTLIJNEN 2012/19/UE EN 2006/66/CE, DE COMPONENTEN VAN EEN PRODUCT MOET WORDEN GESCHIEDEN, VERZAMELD, GERECYCLEERD OF VERWIJDERD IN OVEREENSTEMMING MET DE MILIEUVOORSCHRIFTEN. APPARATEN, BATTERIJEN, OLIE, MOET DE VERPAKKING WORDEN GEDEPONEERD IN DE AFVALVERWERKING AFVAL, ZOALS STORTPLAATSEN. NEEEM CONTACT OP MET UW GEMEENTE NAAR DE DICHTSTBIJZIJNDE AGENTSCHAP KUNNEN HERHALEN OF HET VERZAMELEN VAN DEZE AFVALSTOFFEN TE VINDEN.

**ES-RECICLADO DE LOS RESIDUOS:**

LAS HERRAMIENTAS, LOS ACCESORIOS Y LOS ENVASES TIENEN QUE SEGUIR LA VÍA DE RECICLAJE ADECUADA. EN VIRTUD DE LAS DIRECTIVAS EUROPEAS 2012/19/UE Y 2006/66/CE, LOS COMPONENTES DE UN PRODUCTO DEBEN SEPARARSE, RECOGERSE, RECICLARSE O ELIMINARSE DE ACUERDO CON LAS REGLAMENTACIONES MEDIOAMBIENTALES VIGENTES. LOS APARATOS, BATERÍAS, PILAS, ACEITES, ENVASES DEBERÁN LLEVARSE A LOS CENTROS DE ELIMINACIÓN DE RESIDUOS ESPECIALES TALES COMO LOS ECOPARQUES. PEDIR INFORMACIÓN AL MUNICIPIO PAR CONOCER EL CENTRO MÁS CERCANO APTO PARA RECICLAR O RECOGER DICHS RESIDUOS.

**PT-RECICLAGEM DO LIXO:**

AS FERRAMENTAS, ACESSÓRIOS E SUAS EMBALAGENS DEVEM SEGUIR UM CANAL DE RECICLAGEM ADAPTADO. CONFORMEMENTE ÀS DIRETIVAS EUROPEIAS 2012/19/UE E 2006/66/CE, OS COMPONENTES DE UM PRODUTO DEVEM SER SEPARADOS, RECOLHIDOS, RECICLADOS OU ELIMINADOS DE ACORDO COM AS REGULAMENTAÇÕES AMBIENTAIS EM VIGOR. OS APARELHOS, BATERIAS, PILHAS, ÓLEOS E EMBALAGENS DEVERÃO SER DEPOSITADOS NOS SISTEMAS DE ELIMINAÇÃO DE DETRITOS ESPECIAIS, TAIS COMO UNIDADES DE TRIAGEM DE DETRITOS. INFORMAR-SE JUNTO AO SEU CONCELHO MUNICIPAL PARA CONHECER O ÓRGÃO MAIS PRÓXIMO HABILITADO A EVACUAR OU RECOLHER ESTES DETRITOS.

**IT-RICICLAGGIO DEI RI\_UTI:**

GLI APPARECCHI, I LORO ACCESSORI ED IMBALLAGGI DEVONO ESSERE SOTTOPOSTI AD UN PROCESSO DI RICICLAGGIO APPROPRIATO. IN CONFORMITÀ CON LE DIRETTIVE EUROPEE 2012/19/UE E 2006/66/CE, I COMPONENTI DI UN PRODOTTO DEVONO ESSERE SEPARATI, RACCOLTI, RICICLATI O SMALTITI IN CONFORMITÀ CON LE NORMATIVE AMBIENTALI IN VIGORE. GLI APPARECCHI, LE BATTERIE, LE PILE, GLI OLI, GLI IMBALLAGGI DOVRANNO ESSERE CONFERITI NEI SISTEMI DI SMALTIMENTO DEI RI\_UTI SPECIALI COME LE ISOLE ECOLOGICHE. INFORMARSI PRESSO IL PROPRIO COMUNE PER SAPERE QUAL È L'ENTE PIÙ VICINO IN GRADO DI FARE IL TRATTAMENTO O LA RACCOLTA DIFFERENZIATA DI QUESTI RI\_UTI

**EN-WASTE RECYCLING:**

THE TOOLS, ACCESSORIES AND THEIR PACKAGING MUST USE AN APPROPRIATE RECYCLING CHANNEL. IN COMPLIANCE WITH EUROPEAN DIRECTIVES 2012/19/UE AND 2006/66/CE, A PRODUCT'S COMPONENTS MUST BE SEPARATED, COLLECTED, RECYCLED OR ELIMINATED IN ACCORDANCE WITH THE ENVIRONMENTAL REGULATIONS IN FORCE. THE APPLIANCE, BATTERIES, OILS AND PACKAGING MUST BE DEPOSITED IN THE SPECIAL WASTE ELIMINATION SYSTEMS SUCH AS THE WASTE COLLECTION CENTRES. ASK YOUR COMMUNE FOR INFORMATION ON THE NEAREST ORGANISATION IN A POSITION TO REPROCESS OR COLLECT THIS WASTE

|                                     |   |   |
|-------------------------------------|---|---|
|                                     | Ne pas exposer la machine à la pluie :    | X |
|                                     | Stel het machine niet bloot aan regen :   |   |
|                                     | Non esporre lo macchinario alla pioggia : |   |
|                                     | No exponer la máquina a la lluvia :       |   |
|                                     | Não expor a máquina à chuva :             |   |
| Do not expose the machine to rain : |   |   |







EnergySaw-165ASP

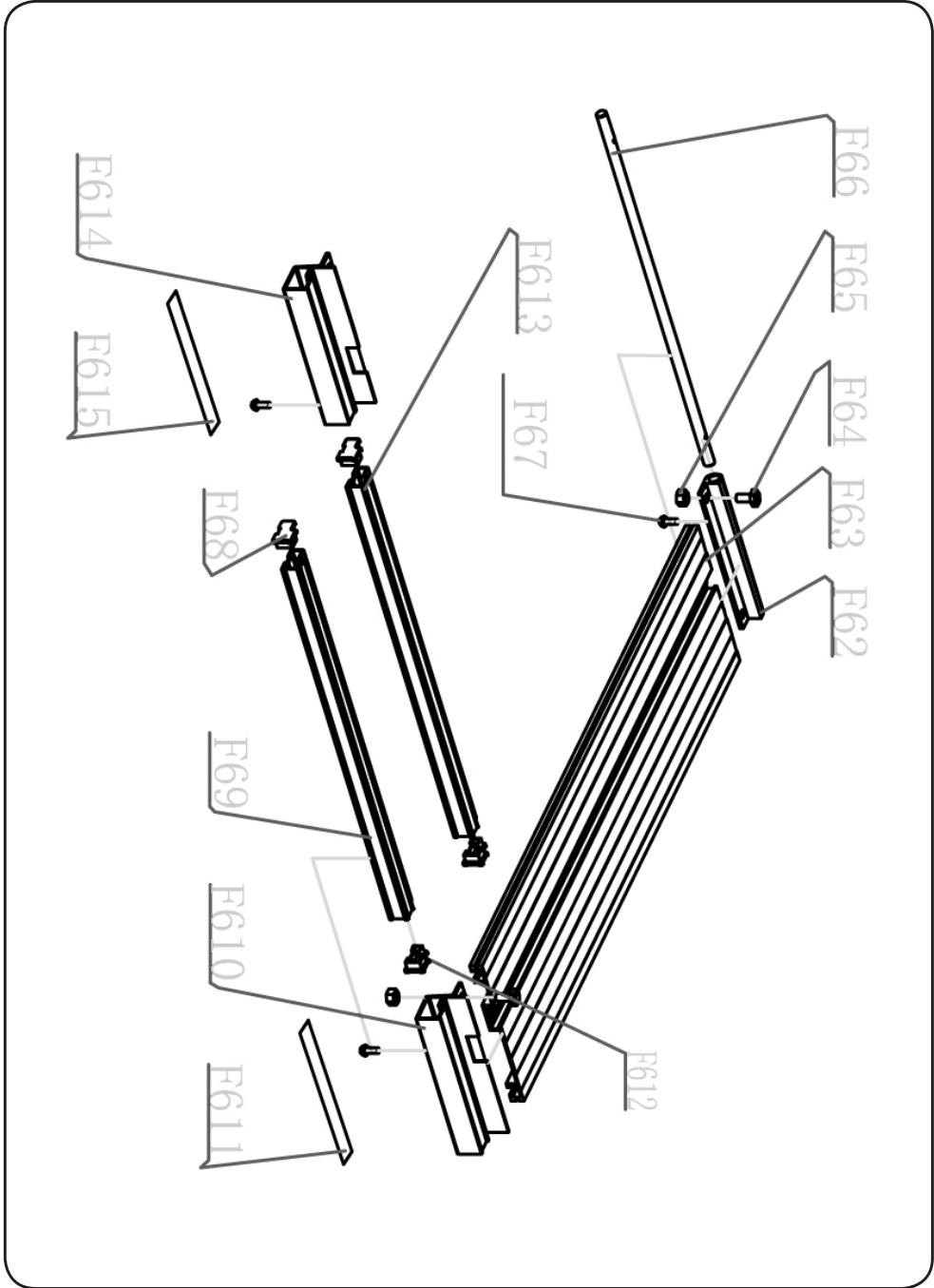



EnergySaw-165ASP

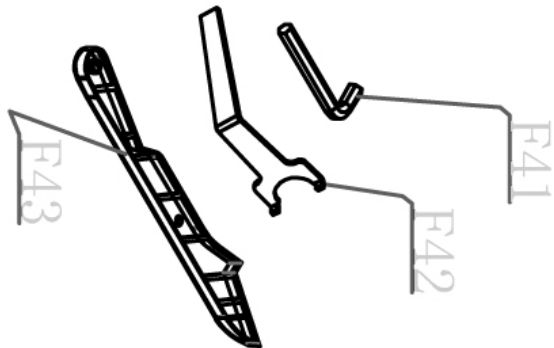
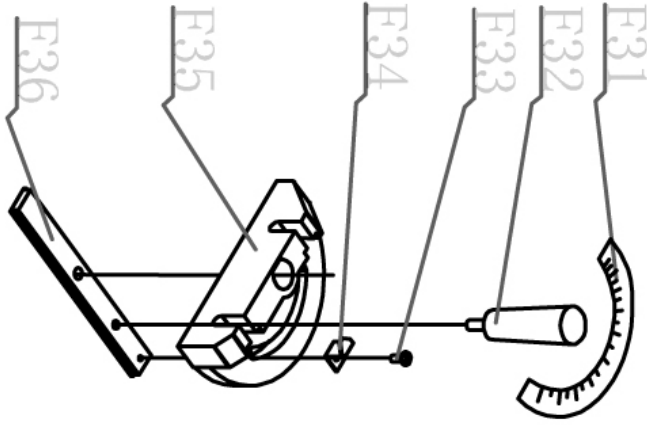





# EnergySaw-165ASP

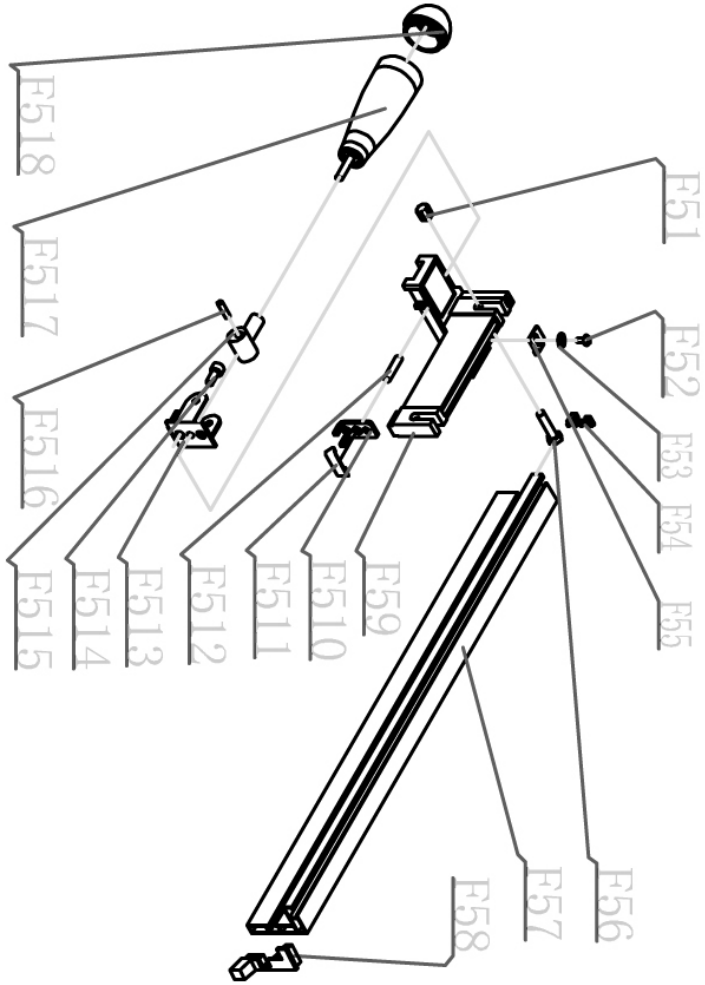



Plaques signalétiques - Naamplaatjes - Placas de identificación - Placas de identificação - Targhette - Machine labels

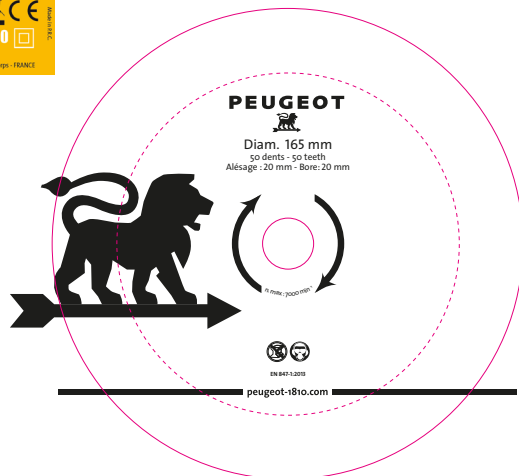
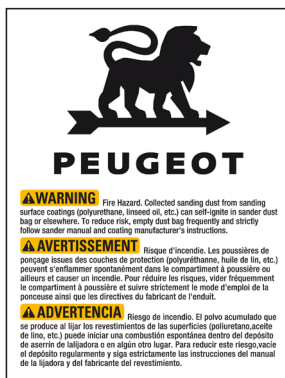
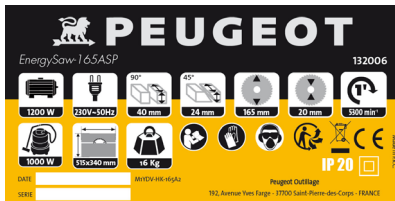
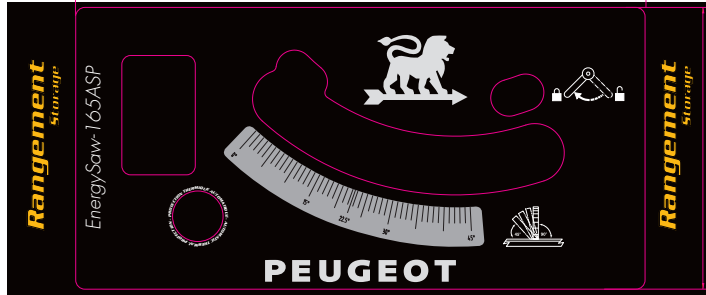



# PEUGEOT

DECLARATION CE DE CONFORMITE  
DECLARACION DE CONFORMIDAD  
DICHIARAZIONE DI CONFORMITA

VERKLARING VAN OVEREENSTEMMING  
DECLARAÇÃO DE CONFORMIDADE  
DECLARATION OF CE CONFORMITY

Le soussigné,  
Ondergetekende,  
El suscrito,  
O abaixo assinado,  
Il sottoscritto,  
The undersigned,

## PEUGEOT OUTILLAGE

192, Avenue Yves Farge - 37700 St. Pierre-des-Corps - FRANCE  
Tél. : 02 36 16 71 46 - Fax : 02 36 16 71 40

Déclare par la présente que,  
Verklaart hiermede dat,  
Declaro por la presente que,  
Declara pela presente que,  
Dichiare che,  
Declares that,

### CODE

PEUGEOT / 132006 / EnergySaw-165ASP / M1YDV-HK-165A2

Scie de table / Table saw / Sierra de mesa / Serra da tabela / Sega da banco / Tafelzaag

Est conforme et satisfait aux normes CE:  
In overeenstemming is met en Voldoet aan EG richtlijnen:  
Cumple con la directivas de la CE:  
Respeita e está em conformidade com as normas CE:  
È conforme alle direttive CEE:  
Complies with the EEC standards:

Directive: 2006/95/EC 2006/42/EC 2014/30/EU

EN Standard Code:  
EN61029-1 :2009/A11:2010  
EN61029-2-1:2012  
EN55014-1 :2006/A2 :2011  
EN55014-2:2015  
EN61000-3-2:2014  
EN61000-3-11:2000

Personne autorisée à  
constituer le dossier technique :  
Christophe HUREL



Christophe HUREL,  
Président Directeur Général  
10/01/2018  
Fait à Saint Pierre-des-Corps

Attestation de type (EC type) N° M6A 15 11 77731 021

Rapport (report) N° 7040314110601-01

TUV SUD Products Service GmbH - Zertifizierstelle  
Ridlerstrasse 65 - 80339 München - GERMANY  
Enregistré sous (registered under) N° 0123



# PEUGEOT

## BON DE GARANTIE

**1 - Objet de la garantie :**  
La garantie porte exclusivement sur les vices de fabrication ou les vices de matières.  
Elle nous oblige à l'échange ou à la réparation des pièces reconnues hors d'usage.

**2 - Durée de la garantie :**  
La garantie est de 24 mois à dater de la livraison du matériel à l'utilisateur (facture ou ticket de caisse à fournir).

Les échanges ou réparations faites au titre de la garantie ne peuvent avoir pour effet de prolonger celle-ci.  
Les frais de port ALLER sont à la charge de l'utilisateur.

**3 - Réserves :**  
La garantie ne s'applique en aucun cas aux réparations effectuées en dehors de nos réparateurs agréés.  
En aucun cas, durant la période de garantie, le matériel ne devra être démonté.

## GARANTIEKAART

**1 - Doel van de garantie:**  
De garantie heeft uitsluitend betrekking op fabricagefouten of gebreken in materialen.  
Het dwingt ons om uit te wisselen of reparatie van erkende onbruikbare onderdelen.

**2 - Duur van de garantie:**  
De garantie bedraagt 24 maanden vanaf de levering van apparatuur voor de gebruiker (factuur of kassabon te verstrekken).  
De uitwisseling of reparaties onder garantie niet te verlenen.  
GO verzendkosten zijn voor rekening van de gebruiker.

**3 - Reserves:**  
De garantie geldt niet in alle reparaties die buiten onze goedgekeurde reparateurs.  
In ieder geval gedurende de garantie, moet het materiaal worden verwijderd.

## TARJETA DE GARANTÍA

**1 - Objeto de la garantía:**  
La garantía sólo se referirá a los defectos de fabricación o defectos en los materiales.  
Nos obliga a cambiar o reparación de las piezas fuera de servicio reconocido.

**2 - Duración de la garantía:**  
La garantía es de 24 meses a partir de la entrega de equipos para el usuario (factura o recibo que se den).  
Los intercambios o reparaciones bajo garantía no tendrá que prolongarse.  
GO gastos de envío correrán a cargo del usuario.

**3 - Reservas:**  
La garantía no se aplica en todas las reparaciones realizadas fuera de nuestros talleres de reparación autorizados.  
En cualquier caso, durante el período de garantía, el material debe ser removido.

## CARTÃO DE GARANTIA

**1 - Finalidade da garantia:**  
A garantia só relacionar com defeitos de fabricação ou defeitos em materiais.  
Ela nos obriga a troca ou reparo de peças inservíveis reconhecidos.

**2 - Duração da Garantia:**  
A garantia é de 24 meses a partir da entrega de equipamentos para o usuário (factura ou recibo a ser fornecido).  
Trocas ou reparos sob a garantia não terá que prolongar-la.  
GO porte serão custeadas pelo usuário.

**3 - Reservas:**  
A garantia não se aplica a quaisquer reparos feitos fora das nossas oficinas aprovadas.  
Em qualquer caso, durante o período de garantia, o material deve ser removido.

## GARANZIA

**1 - Oggetto della garanzia:**  
La garanzia si riferisce esclusivamente alla difetti di fabbricazione o difetti nei materiali.  
Ci costringe a scambio o la riparazione di parti inutilizzabili riconosciuti.

**2 - Durata della garanzia:**  
La garanzia è di 24 mesi dalla consegna delle attrezzature per l'utente (fattura o ricevuta da fornire).  
Scambi o riparazioni in garanzia non sarà necessario prolungarla.  
GO spese di spedizione sono a carico dell'utente.

**3 - Riserve:**  
La garanzia non si applica in tutte le riparazioni effettuate al di fuori dei nostri riparatori autorizzati.  
In ogni caso, durante il periodo di garanzia, il materiale deve essere rimosso.

## WARRANTY

**1 - Scope of the warranty :**  
The warranty shall only apply to manufacturing defects or material defects.  
We are obliged to exchange or repair parts that are identified as being unusable

**2 - Lifetime warranty :**  
The warranty shall be valid for 24 months from the delivery date of the equipment to the user (invoice or till receipt must be provided).  
Exchanges or repairs carried out under the warranty shall not extend the original warranty period.  
The user shall be responsible for original shipping charges.

**3 - Reservations :**  
The warranty shall not under any circumstances cover repairs carried out by a non-authorized repairer.  
The equipment should not be dismantled under any circumstances during the warranty period.

| DATE D'ACHAT      | RÉFÉRENCE MACHINE | CACHET DU DISTRIBUTEUR |
|-------------------|-------------------|------------------------|
| DATUM VAN AANKOOP | HOMING            | DEALER STEMPEL         |
| FECHA DE COMPRA   | HOMING            | COMERCIANTE DE SELLOS  |
| DATA DA COMPRA    | HOMING            | SELO REVENDEDOR        |
| DATA DI ACQUISTO  | HOMING            | TIMBRO DEL RIVENDITORE |
| PURCHASE DATE     | MACHINE CODE      | DISTRIBUTOR'S STAMP    |
|                   |                   |                        |

## SERVICE APRÈS VENTE - AFTER SALE SERVICE

Peugeot Outillage - 192, Avenue Yves Farge - 37700 St. Pierre-des-Corps - FRANCE - Tél. : 02 36 16 71 44 - Fax : 02 36 16 71 40